

M12系列 M12 SERIES



M12现场连接型连接器



型号标志代号

PART NUMBER SYSTEM









材料和技术参数

Material & Specifications

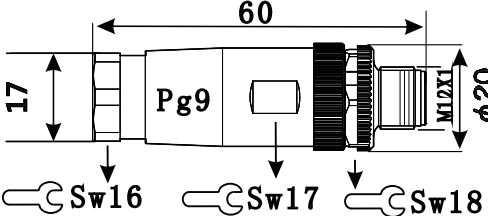
针数 Number of Contact	3	4	5	8
针位排列 (从针端看) The Contact arranges (Comply with the needle direction)				
锁紧方式 Coupling	螺纹锁紧 Threaded Coupling			
外壳材料 Shell Material	热塑塑料 PA66 阻燃等级V-0 Thermoset Plastics Pa66, Flame Retardant Rating V-0			
绝缘体材料 Insert Material	热塑塑料 PA66 阻燃等级V-0 Thermoset Plastics Pa66, Flame Retardant Rating V-0			
接触件材料 Contact Material	铜镀金 Copper(gold-plated)			
接线方式 Termination	螺钉 Screw			
电缆直径 Cable Diameter	4-6mm/6-8mm			
线规 Wire Size	螺钉0.14-0.5mm (AWG 26-20),			
防护等级 Protection Degree	IP67			
接插次数 Mating Cycle	≥ 100次			
工作温度范围 Temperature Range	-25°C--+85°C			
额定电压(AC.V) Rated Voltage	250V	60V		30V
耐压 (AC.V)1min Withstanding Voltage	2500V	1500V		800V
额定电流 (A) Rated Current	4A			2A
接触电阻 (mΩ) Contact Resistance	≤3mΩ			
绝缘组别 Insulation Division	III			
过电保护等级 Over Voltage Protection Level	II			
污染等级 Pollution Level	3			

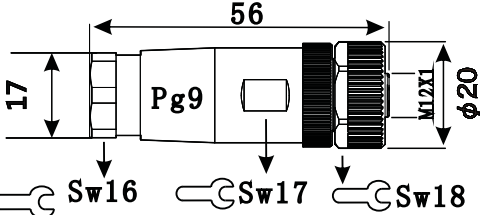

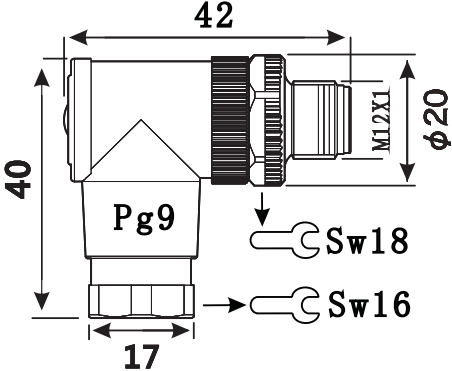

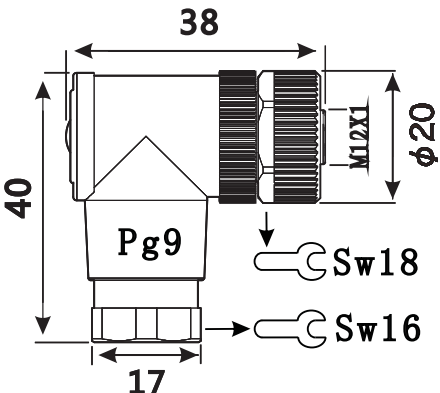

M12系列 M12 SERIES

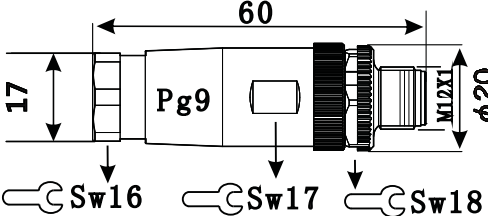

图例描述 Description Figure	尺寸图 Drawing unit:mm	针数 Contacts	电缆出口直径 (mm) Cable Diameter	订货号 Ordering No.
A型直线型公头, 针, 螺钉 Male Cable Plug, Regular Type threaded Coupling(meta) 		3	4-6(PG7)	M12AN-I-03
		6-8(PG9)	M12AN-II-03	
		4	4-6(PG7)	M12AN-I-04
		6-8(PG9)	M12AN-II-04	
		5	4-6(PG7)	M12AN-I-05
		6-8(PG9)	M12AN-II-05	
A型直线型母头, 孔, 螺钉 Female Cable Plug, Regular Type threaded Coupling(meta) 		3	4-6(PG7)	M12AH-I-03
		6-8(PG9)	M12AH-II-03	
		4	4-6(PG7)	M12AH-I-04
		6-8(PG9)	M12AH-II-04	
		5	4-6(PG7)	M12AH-I-05
		6-8(PG9)	M12AH-II-05	
A型弯头型公头, 针, 螺钉 Male Cable Plug, 90° Type threaded Coupling(meta) 		3	4-6(PG7)	M12WAN-I-03
		6-8(PG9)	M12WAN-II-03	
		4	4-6(PG7)	M12WAN-I-04
		6-8(PG9)	M12WAN-II-04	
		5	4-6(PG7)	M12WAN-I-05
		6-8(PG9)	M12WAN-II-05	
A型弯头型母头, 孔, 螺钉 Female Cable Plug, 90° Type threaded Coupling(meta) 		3	4-6(PG7)	M12WAH-I-03
		6-8(PG9)	M12WAH-II-03	
		4	4-6(PG7)	M12WAH-I-04
		6-8(PG9)	M12WAH-II-04	
		5	4-6(PG7)	M12WAH-I-05
		6-8(PG9)	M12WAH-II-05	
8	4-6(PG7)	M12WAH-I-08		
6-8(PG9)	M12WAH-II-08			

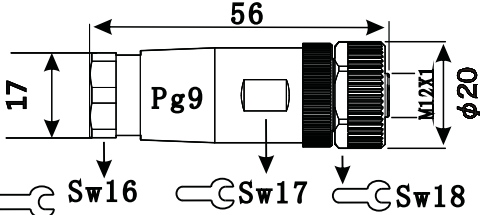

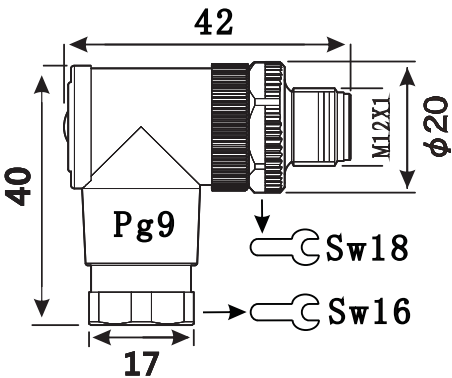

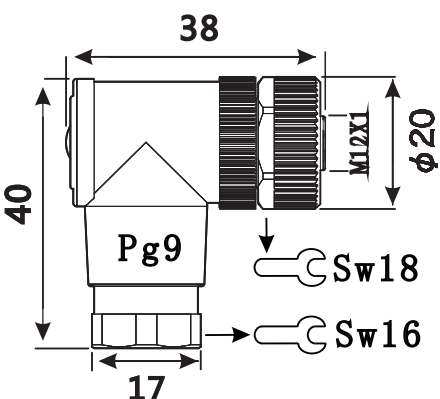

M12系列 M12 SERIES

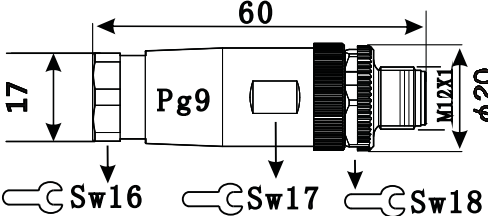

图例描述 Description Figure	尺寸图 Drawing unit:mm	针数 Contacts	电缆出口直径 (mm) Cable Diameter	订货号 Ordering No.
B型直线型公头, 针, 螺钉 Male Cable Plug, Regular Type threaded Coupling(meta) 		3	4-6(PG7)	M12BN-I-03
			6-8(PG9)	M12BN-II-03
		4	4-6(PG7)	M12BN-I-04
			6-8(PG9)	M12BN-II-04
		5	4-6(PG7)	M12BN-I-05
			6-8(PG9)	M12BN-II-05
B型直线型母头, 孔, 螺钉 Female Cable Plug, Regular Type threaded Coupling(meta) 		3	4-6(PG7)	M12BH-I-03
			6-8(PG9)	M12BH-II-03
		4	4-6(PG7)	M12BH-I-04
			6-8(PG9)	M12BH-II-04
		5	4-6(PG7)	M12BH-I-05
			6-8(PG9)	M12BH-II-05
B型弯头型公头, 针, 螺钉 Male Cable Plug, 90° Type threaded Coupling(meta) 		3	4-6(PG7)	M12WBN-I-03
			6-8(PG9)	M12WBN-II-03
		4	4-6(PG7)	M12WBN-I-04
			6-8(PG9)	M12WBN-II-04
		5	4-6(PG7)	M12WBN-I-05
			6-8(PG9)	M12WBN-II-05
B型弯头型母头, 孔, 螺钉 Female Cable Plug, 90° Type threaded Coupling(meta) 		3	4-6(PG7)	M12WBH-I-03
			6-8(PG9)	M12WBH-II-03
		4	4-6(PG7)	M12WBH-I-04
			6-8(PG9)	M12WBH-II-04
		5	4-6(PG7)	M12WBH-I-05
			6-8(PG9)	M12WBH-II-05

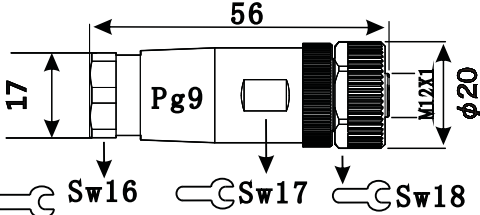
M12系列 M12 SERIES

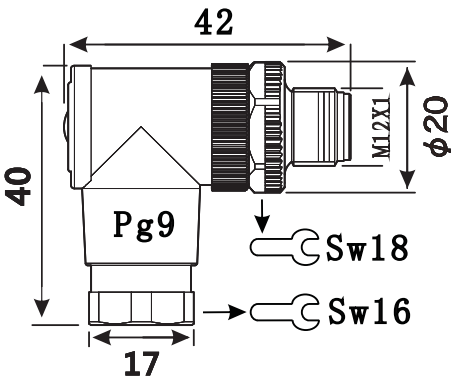

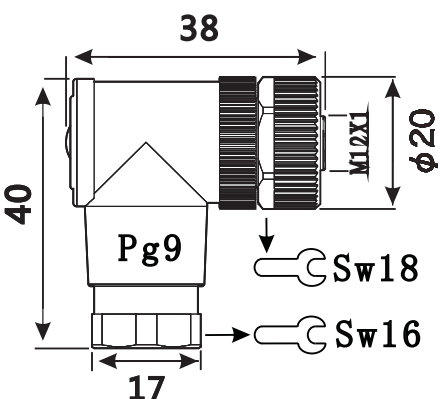
图例描述 Description Figure	尺寸图 Drawing unit:mm	针数 Contacts	电缆出口直径 (mm) Cable Diameter	订货号 Ordering No.
D型直线型公头, 针, 螺钉 Male Cable Plug, Regular Type threaded Coupling(meta) 		3	4-6(PG7)	M12DN-I-03
			6-8(PG9)	M12DN-II-03
		4	4-6(PG7)	M12DN-I-04
			6-8(PG9)	M12DN-II-04
		5	4-6(PG7)	M12DN-I-05
			6-8(PG9)	M12DN-II-05
D型直线型母头, 孔, 螺钉 Female Cable Plug, Regular Type threaded Coupling(meta) 		3	4-6(PG7)	M12DH-I-03
			6-8(PG9)	M12DH-II-03
		4	4-6(PG7)	M12DH-I-04
			6-8(PG9)	M12DH-II-04
		5	4-6(PG7)	M12DH-I-05
			6-8(PG9)	M12DH-II-05
D型弯头型公头, 针, 螺钉 Male Cable Plug, 90° Type threaded Coupling(meta) 		3	4-6(PG7)	M12WDN-I-03
			6-8(PG9)	M12WDN-II-03
		4	4-6(PG7)	M12WDN-I-04
			6-8(PG9)	M12WDN-II-04
		5	4-6(PG7)	M12WDN-I-05
			6-8(PG9)	M12WDN-II-05
D型弯头型母头, 孔, 螺钉 Female Cable Plug, 90° Type threaded Coupling(meta) 		3	4-6(PG7)	M12WDH-I-03
			6-8(PG9)	M12WDH-II-03
		4	4-6(PG7)	M12WDH-I-04
			6-8(PG9)	M12WDH-II-04
		5	4-6(PG7)	M12WDH-I-05
			6-8(PG9)	M12WDH-II-05

安装指南

Assembly instruction

针/孔电缆连接器，裸线度量，螺纹接口，无屏蔽

Strip measures male/female cable connector, screw fermination, no shieldable

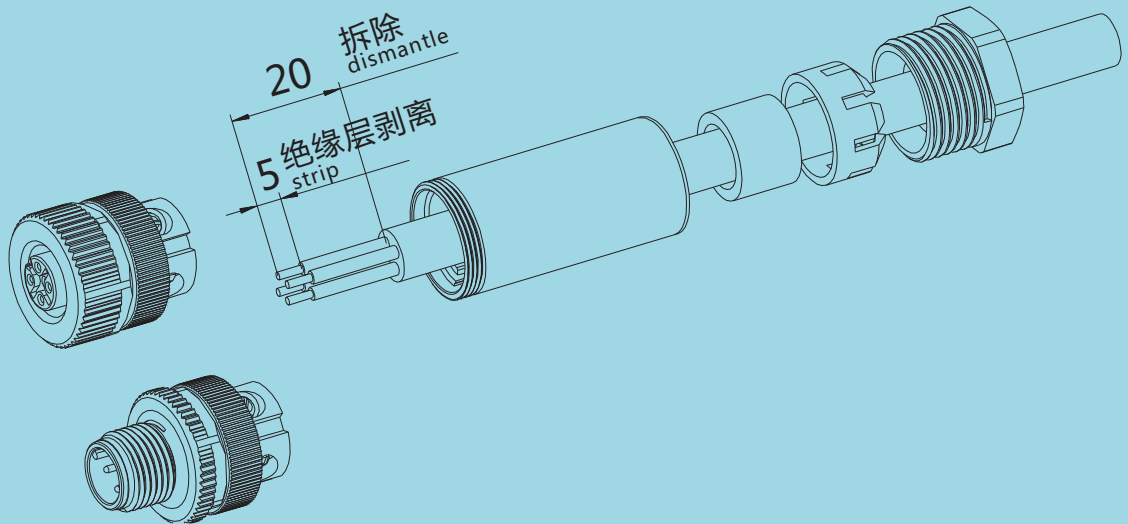

针/孔弯角连接器，裸线度量，螺纹接口，无屏蔽

Strip measures male/female angle connector, screw fermination, no shieldable

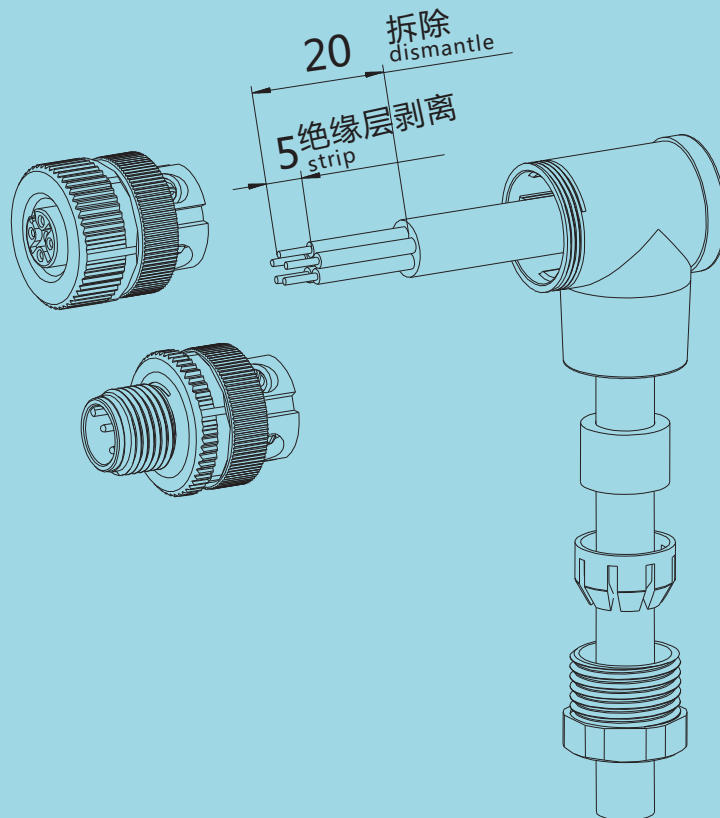

M12系列 M12 SERIES



安装指南

Assembly instruction



A型公头

	X	Y
1	2.5	0.0
2	0.0	2.5
3	-2.5	0.0
4	0.0	-2.5
5	0.0	0.0



B型公头



D型公头



A型母头

	X	Y
1	-2.5	0.0
2	0.0	2.5
3	2.5	0.0
4	0.0	-2.5
5	0.0	0.0



B型母头



D型母头



A型公头

	X	Y
1	2.69	0.57
2	0.57	2.69
3	-1.66	2.20
4	-2.75	0.19
5	-1.94	-1.94
6	0.19	-2.75
7	2.20	-1.65
8	0.00	0.00



母头

	X	Y
1	-2.69	0.57
2	-0.57	2.69
3	1.66	2.20
4	2.75	0.19
5	1.94	-1.94
6	-0.19	-2.75
7	-2.20	-1.65
8	0.00	0.00

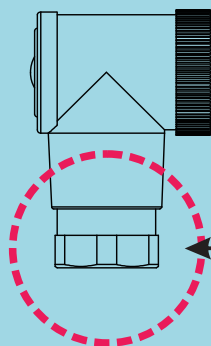

Pg9适合锁紧6-8mm的线缆

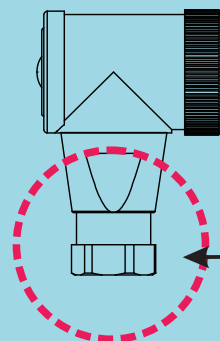
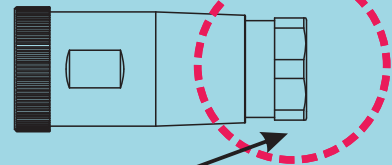

Pg7适合锁紧4-6mm的线缆

